



IMPERIAL LINE





Artigianalità
e industrializzazione,
soluzioni,
legni certificati,
lavorazioni ricercate e
tecnologia, manualità,
finiture, dettagli,
affidabilità e
flessibilità, estetica,
qualità.

EN CRAFTSMANSHIP AND INDUSTRIALISATION,
SOLUTIONS, CERTIFIED WOOD, EXCLUSIVE
WORKMANSHIP AND TECHNOLOGY, DEXTERITY,
FINISHING TOUCHES, DETAILS, RELIABILITY AND
FLEXIBILITY, AESTHETICS, QUALITY.

FR CARACTÈRE ARTISANAL ET INDUSTRIEL,
SOLUTIONS, BOIS CERTIFIÉS, FAÇONNAGES
RECHERCHÉS ET TECHNOLOGIE, MANUALITÉ,
FINITIONS, DÉTAILS, FIABILITÉ ET FLEXIBILITÉ,
ESTHÉTIQUE, QUALITÉ.

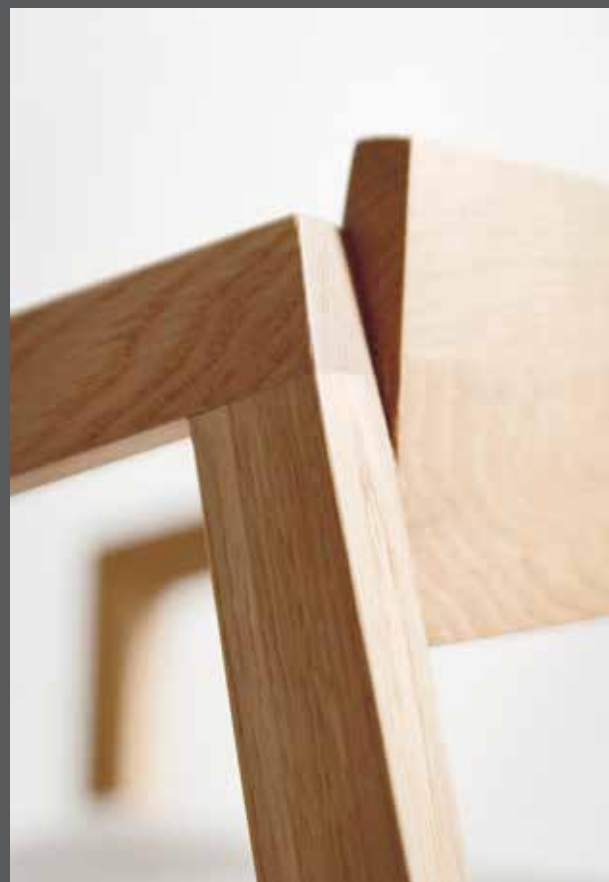

105.600

I minuti dedicati a ogni singolo dettaglio affinché sia esemplare.
The minutes dedicated to every single detail in order to make sure that everything is perfect.
Les minutes dédiées à chaque détail afin qu'il soit parfait.



9.766

Le combinazioni possibili fra tessuti e legni.
The available combinations of fabrics and wood types.
Les combinaisons possibles entre les tissu et les bois



660

Le ore riservate ogni anno allo sviluppo di nuove proposte.
The number of hours that we spend every year developing new proposals.
Les heures réservées chaque année au développement de nouvelles propositions.

Indice

contents / index

SEDIE

chairs
chaises

100	Baba
102	Bistrot
16,86	Bolla
54,76	Brio
74	Buddy
88	Cannella
112	Coco
26,28,80	Damblè
58	Elle
39,41,42	Feng Shui
64	Good
72	Guggenheim
79	Hermitage
47,48,49	Hula Hoop
92	La-Mu
66	Manila
104	Met
82	Minuetto
90	National
70	Nordica
8,12,13	Operà
60	Peggy
94	Queen
108	Retrò
110	Salsa
44	Viktor
22,25	Zen

POLTRONE

armchairs
fauteuils

18,20,106	Bolla
53,77	Brio
27,33,34	Damblè
84	Diva
78	Hermitage
46	Hula Hoop
110	Merengue
9	Operà
109	Retrò
68	Twist
23,24	Zen

SGABELLI

stools
tabourets

26,28	Damblè
73	Guggenheim
47	Hula Hoop
98	Lussuria
67	Manila
9,12	Operà
36,107	Up

TAVOLI

tables
tables

96	Barboun
106	Bridge
86	Étoile
62	Essenza
38,40,42	Feng Shui
46,49	Hula Hoop
8,11,19,79	Operà
80	Perla
33,57	Tai-gà
76	Tetris
68	Twist
93	Ufo

OUTDOOR

outdoor
outdoor

116-119	Oplà
---------	------

FINITURE

finishes
finitions

122-134	tessuti, fabrics, tissu
135	PELLI, leather, cuir
136	fenix NTM®
137	metalli, metal, métal
137	vetri, glasses, verres
138	legni, wood, bois
139	materiali outdoor, outdoor materials, finition outdoor

Operà

IT La forma slanciata delle gambe caratterizza Operà, collezione composta da sedia, poltroncina, tavolo e sgabello.

EN Tapered legs distinguish Operà, a collection comprising a chair, armchair, table and stool.

FR La forme élancée des piètements caractérise Operà, collection composée de chaise, fauteuil, table et tabouret.

O

tavolo table
sedia chair
poltrona armchair
sgabello stool





fenix NTM® nero ingo
smoked grey oak

○
top tavolo table top
1400 x 1400
fenix NTM® blu fes

○
top tavolo table top
1800 x 900
ash grey oak

○
top tavolo table top
Ø 1250
coal black oak



○
tavolo table
2000 x 900
fenix NTM® grigio bromo
snow oak



○
tavolo table
Ø 1250
fenix NTM® bianco malé
smoked grey oak

Operà stool
moon grey oak
Operà s
black jack 705
snow oak



INDOOR / OUTDOOR
COLLECTION

IT Le gambe in legno massello sono levigate e stondate una a una: un dettaglio ricercato dal sapore artigianale.

EN The solid wood legs are smoothed and rounded one by one: a refined detail with an artisan flavour.

FR Les piètements en bois massif sont polis et arrondis un par un: un détail recherché à la saveur artisanale.

Operà s
flirt 600
coal black oak
Operà s
flirt 605
ash grey oak
Operà s
flash 707
natural oak



OPERÀ S

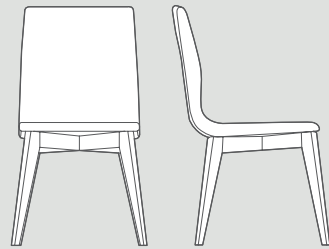

W 500
H 880
D 570

finitura seduta
sitting finish
finition assise



finitura gambe
legs finishes
finition pieds

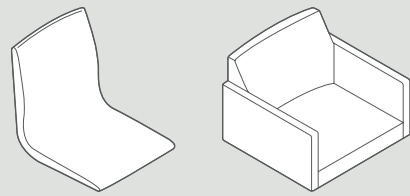

girevole, swivel, pivotant

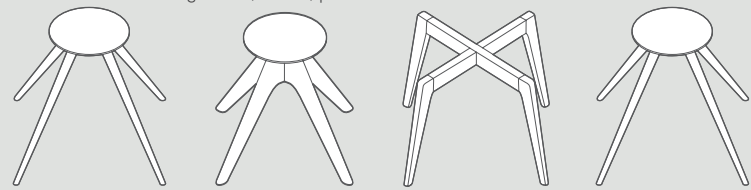

razza in metallo
metal four easel
structure en métal

razza in legno
wood four easel
structure en bois

gambe in legno
wood four legs
pieds en bois

razza in legno
wood four easel
structure en bois

OPERÀ P

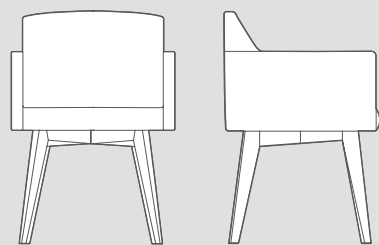

W 570
H 820
D 510

finitura seduta
sitting finish
finition assise



finitura gambe
legs finishes
finition pieds



OPERÀ SGABELLO

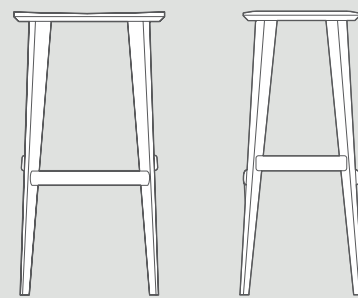

W 440
H 650-800
D 370

finitura seduta
sitting finish
finition assise



finitura gambe
legs finishes
finition pieds



OPERÀ TAVOLO

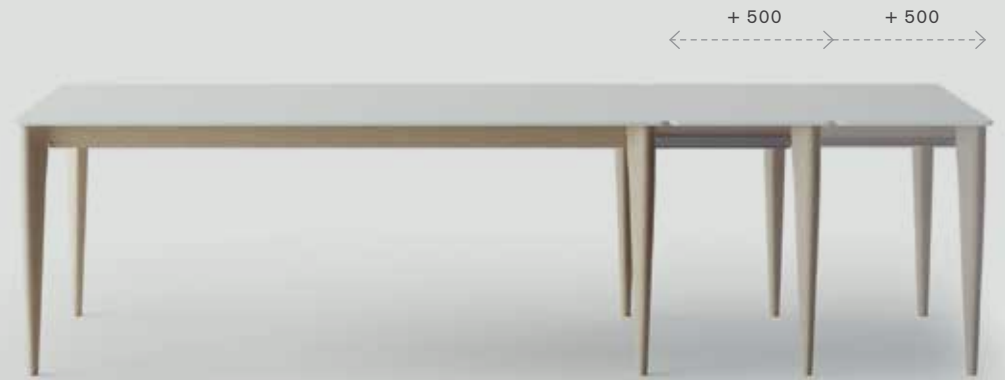

H 770

finitura top
finishes top
finition plan

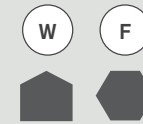

finitura gambe
legs finishes
finition pieds

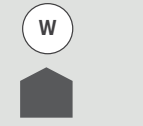

misure
measures
dimensions

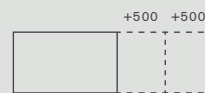

fisso e allungabile
fixed and sliding
fixe et à rallonge

1400 x 1400
1400 x 900
1600 x 900
1800 x 900
2000 x 900
1400 x 1000
1600 x 1000
1800 x 1000
2000 x 1000

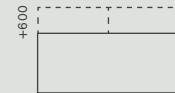

fisso e allungabile
fixed and sliding
fixe et à rallonge

1400 x 1000
1600 x 1000
1800 x 1000



fisso e allungabile
fixed and sliding
fixe et à rallonge

Ø1250
Ø1400



su misura
on measures
sur mesure

caratteristiche
characteristic
caractéristiques



taglio a 45°
45° cut
coupe à 45°

IT **finiture pag. 8-9** da sinistra: **operà s** rovere naturale, tessuto joint 706; **operà tavolo** rovere naturale, top fenix bianco; **operà s** rovere grigio luna, tessuto magic 605; **operà p** metallo bianco opaco, tessuto joint 714; **operà s** metallo nero opaco, tessuto nord wool 401; **operà sgabello** rovere grigio luna.

EN **finishes pag. 8-9** left: **operà s** natural oak and joint 706 fabric, **operà table** in natural oak with fenix white table, **operà s** in moon grey oak and fanric magic 605, **operà p** in matt white metal and joint 714 fabric, **operà s** in matt black metal and nord wool 401 fabric, **operà stool** in moon grey oak.

Bolla

IT Hanno l'imbottitura in poliuretano espanso la seduta e lo schienale di Bolla, disponibile nelle due versioni sedia e poltroncina con braccioli.

EN Polyurethane foam is used for padding the seat and backrest of Bolla, which is available as a chair or small armchair.

FR L'assise et le dossier de Bolla, disponible dans les deux versions chaise et fauteuil avec accoudoirs, ont un rembourrage en polyuréthane expansé.



○

sedia chair
poltrona armchair



Bolla s
nord wool OV200
white matt metal
Bolla p
nord wool 802
black matt metal

IT Impeccabile attorno a un tavolo, Bolla è indicata anche per i luoghi di lavoro, dentro lo studio di casa così come all'interno di ambienti corporate.

EN Impeccable round a table, Bolla is also ideal for work places, in a home office or a corporate environment.

FR Impeccable autour d'une table, Bolla est également indiqué pour les lieux de travail, dans le bureau de la maison ou bien dans des ambiances corporate.

Bolla p
joint 601
chalet oak
joint 903
Operà table
fenix NTM®
verde comodoro
chalet oak

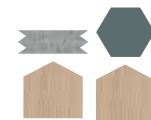

Bolla p
magic 801
terra oak
Bolla p
joint 611
dust oak
Bolla s
magic 802
dust oak



BOLLA S

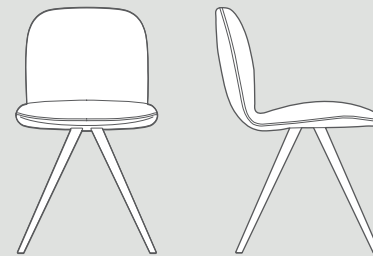

W 440
H 800
D 460

finitura seduta
sitting finish
finition assise

FA

finitura gambe
legs finishes
finition pieds

W

M

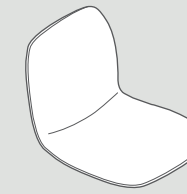

girevole, swivel, pivotant

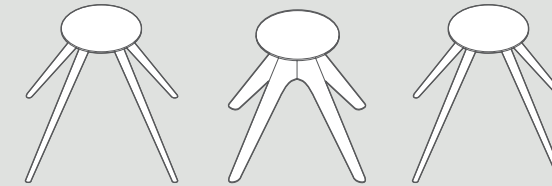

razza in metallo
metal four easel
structure en métal

razza in legno
wood four easel
structure en bois

razza in legno
wood four easel
structure en bois

BOLLA P

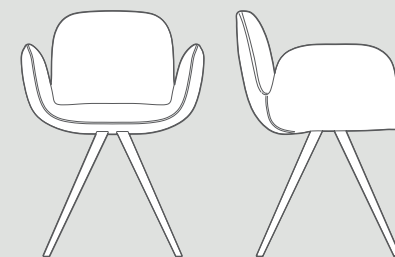

W 590
H 800
D 460

finitura seduta
sitting finish
finition assise

FA

finitura gambe
legs finishes
finition pieds

W

M

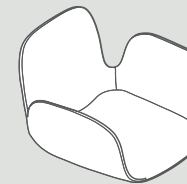

girevole, swivel, pivotant

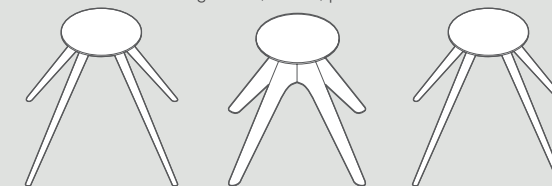

razza in metallo
metal four easel
structure en métal

razza in legno
wood four easel
structure en bois

razza in legno
wood four easel
structure en bois

Zen s
reginarca 500
moon grey oak

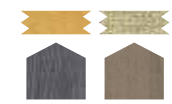

Zen p
magic 802
ash grey oak



○
sedia chair
poltrona armchair



Zen

IT Con il suo design accattivante e la struttura in rovere massello, Zen è una seduta solida e versatile.

EN Attractive design and a solid oak frame make Zen solid, versatile seating.

FR Avec son design séduisant et sa structure en chêne-rouvre massif, Zen est une assise solide et versatile.

IT Zen è ancora più confortevole in versione poltroncina con braccioli.

EN Zen is even more comfortable as a small armchair.

FR Zen est encore plus confortable en version fauteuil avec accoudoirs.



ZEN S

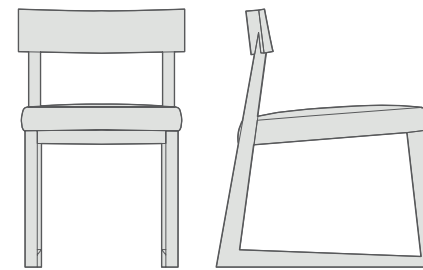

W 500
H 770
D 645

finitura seduta
sitting finish
finition assise



finitura gambe
legs finishes
finition pieds



ZEN P

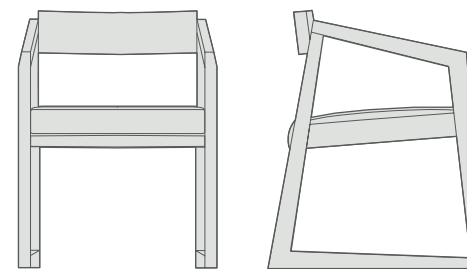

W 575
H 770
D 635

finitura seduta
sitting finish
finition assise



finitura gambe
legs finishes
finition pieds



Zen p
lavasi 600
natural oak
Zen s
magic 802
moon grey oak

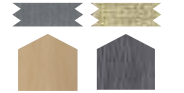

Damblè

IT Sono comode e raffinate le sedute Damblè, con imbottitura morbida e schienale avvolgente.

EN Damblè chairs are comfortable and refined, softly padded with a cocooning backrest.

FR Les assises Damblè sont confortables et raffinées et ont un rembourrage souple et un dossier enveloppant.



O

sedia chair
poltrona armchair
lounge
sgabello stool



○
sgabello stool
sedia chair

Dambè stool
joint 401/603
chalet oak
Dambè s
joint 307
chalet oak



Dambè stool
chalet oak



O

divanetto lounge



Dambè I
dust oak
joint 604/307



IT L'imbottitura di tutte le sedute si può rivestire a piacere, anche con bordino a contrasto.

EN The padding of all our seating can be upholstered to your taste, including contrasting trims.

FR Le rembourrage de toutes les assises peut être revêtu selon son gré, également avec un bord en contraste.

Dambè s
nord wool 600
terra oak

Tai-gà table
fenix NTM® grigio bromo
chalet oak

Dambè p
nord wool 401
chalet oak

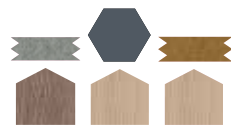

INDOOR / OUTDOOR
COLLECTION

○

sedia chair
poltrona armchair
tavolo Tai-gà table



IT finiture pag. 26-27 da sinistra: **dablè s** rovere terra, tessuto nord wool 600; **dablè sgabello** rovere terra, tessuto nord wool 404; **dablè p** rovere chalet, tessuto nord wool 401; **dablè l** rovere chalet, tessuto joint 405.

EN finishes pag. 26-27 left: **dablè s** terra oak, nord wool 600 fabric; **dablè stool** in terra oak, nord wool 404 fabric; **dablè p** chalet oak, nord wool 401 fabric; **dablè l** chalet oak, joint 405 fabric.



Dablè p
joint 307
chalet oak



DABLÈ S

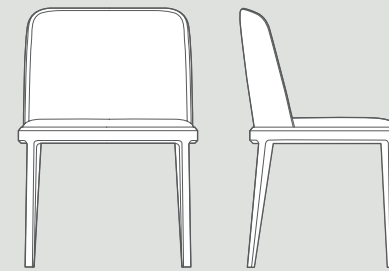

W 530
H 850
D 450

finitura seduta
sitting finish
finition assise



finitura gambe
legs finishes
finition pieds



DABLÈ P

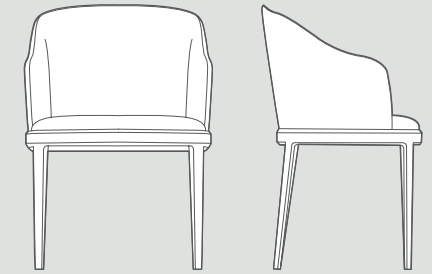

W 530
H 850
D 450

finitura seduta
sitting finish
finition assise



finitura gambe
legs finishes
finition pieds



DABLÈ L

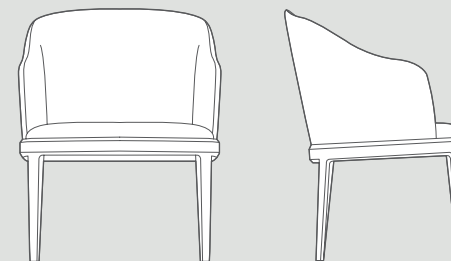

W 530
H 770
D 450

finitura seduta
sitting finish
finition assise



finitura gambe
legs finishes
finition pieds



DABLÈ SGABELLO

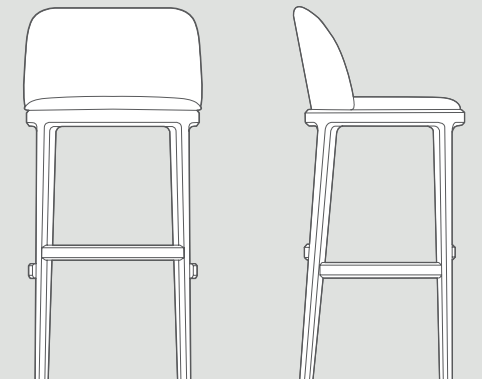

W 470
H 650-900
D 505

finitura seduta
sitting finish
finition assise



finitura gambe
legs finishes
finition pieds



W 470
H 750-1000
D 505

Up

IT Ispirazione nordica per lo sgabello Up, con struttura e poggiatesta in rovere massiccio e seduta a doghe in nylon e fibra di vetro.

EN Nordic inspiration for the Up stool, with solid oak frame and footrest and slatted seat in nylon and glass fibre.

FR Inspiration nordique pour le tabouret Up, avec une structure et un repose-pied en chêne-rouvre massif et une assise à lattes en nylon et fibre de verre.



INDOOR / OUTDOOR
COLLECTION

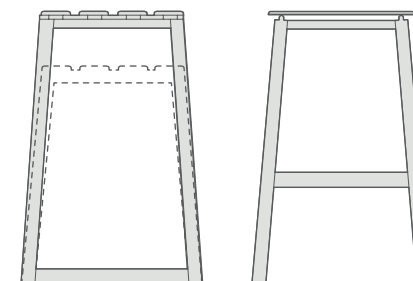

W 440
H 650 / 780
D 440

finitura seduta
sitting finish
finition assise



finitura gambe
legs finishes
finition pieds



Up
black plastic
dust oak
black plastic
natural oak
Up
white plastic
natural oak



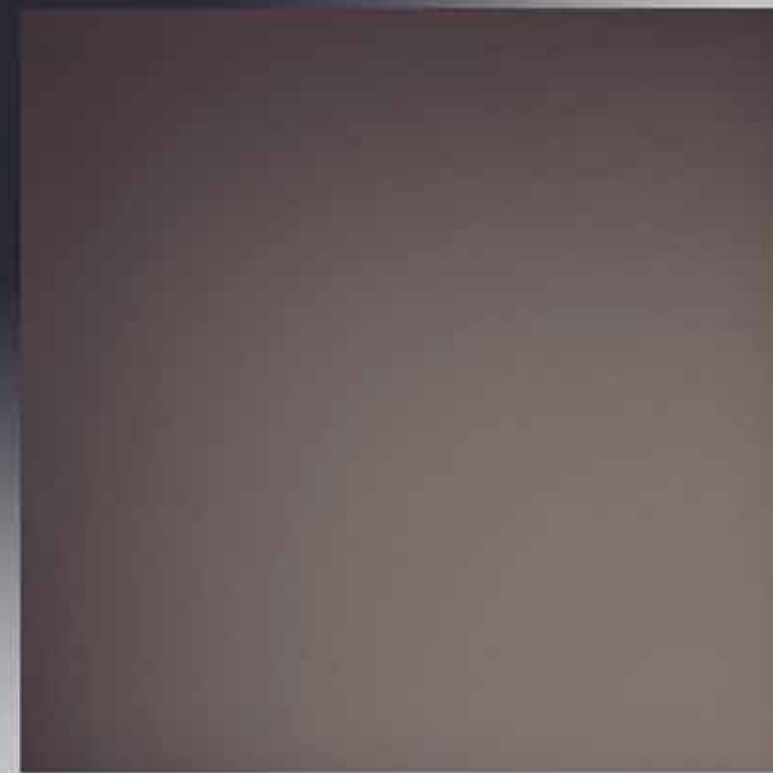
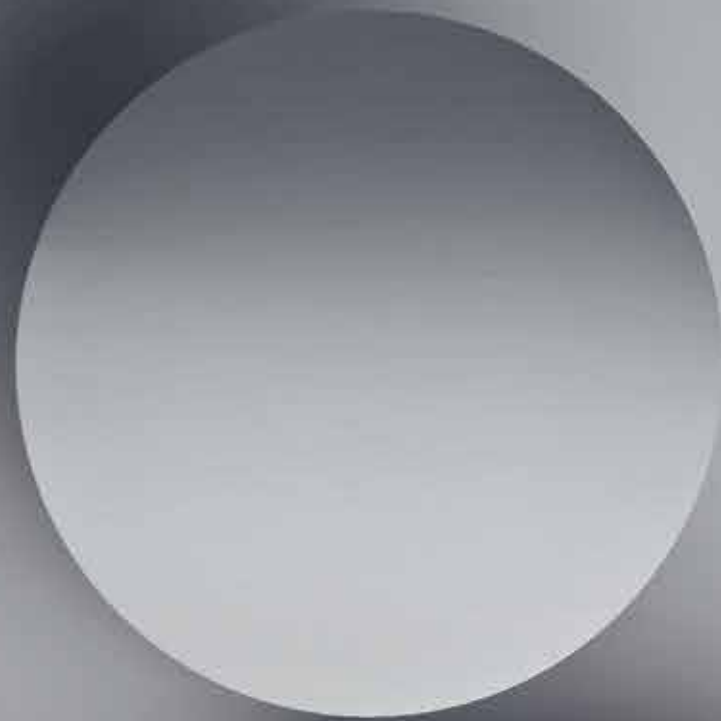

O

sedia chair**tavolo rotondo** round table**tavolo ovale** oval table**tavolo quadrato** square table

Feng Shui

IT Il particolare basamento in legno a incastro è il *leitmotiv* della famiglia Feng Shui, formata dalla sedia e dai tavoli con piani di diverse forme e materiali.

EN A special slotted wooden base is the *leitmotiv* of the Feng Shui family, which comprises a chair and tables in different shapes and materials.

FR La base encastrée particulière en bois est le *leitmotiv* de la famille Feng Shui, formée par la chaise et par les tables avec plateaux de formes et matériaux différents.

○

tavolo table
 Ø 1400
 so wood oak
 fenix NTM® bianco

○

tavolo table
 1400 x 1400
 so wood oak
 fenix NTM® grigio Londra

○

sedia chair
 flirt 400
 moon grey oak

IT La sedia ergonomica Feng Shui ha la scocca in poliuretano espanso resistente e indeformabile.

EN The ergonomic Feng Shui chair has a robust, non-deforming polyurethane foam carcass.

FR La chaise ergonomique Feng Shui a une coque en polyuréthane expansé résistant et indéformable.

Feng Shui chair
 Flirt 605
 coal black oak



Feng Shui table
 fenix NTM® rosso Jaipur
 biscuit oak

Feng Shui
 magic 401
 biscuit oak

Feng Shui
 Joint 305
 coal black oak

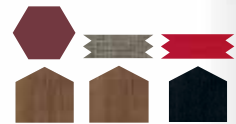

INDOOR / OUTDOOR
 COLLECTION

FENG SHUI

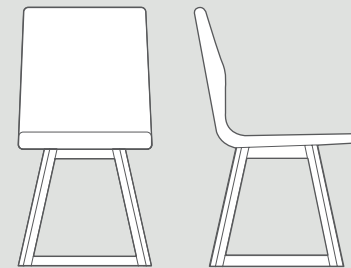

W 435
 H 850
 D 570

finitura seduta
 sitting finish
 finition assise



finitura gambe
 legs finishes
 finition pieds



IT **finiture pag. 38-39** da sinistra:
feng shui ovale fenix NTM® rosso Jaipur; **feng shui rotondo** fenix NTM® bianco, rovere naturale; **feng shui rotondo** fenix NTA®; **feng shui quadrato** fenix NTM® cacao orinoco; **feng shui sedia** tessuto joint 305, rovere naturale.

EN **finishes pag. 38-39** left:
feng shui oval fenix NTM® rosso Jaipur; **feng shui round** fenix NTM® bianco, natural oak; **feng shui round** fenix NTA®; **feng shui square** fenix NTM® cacao orinoco; **feng shui chair** in joint 305 fabric, natural oak.

FENG SHUI TAVOLO



H 770

finitura top
 finishes top
 finition plan

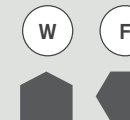

finitura gambe
 legs finishes
 finition pieds



misure
 measures
 dimensions



fisso
 fixed
 fixe

2000 x 1000

fisso
 fixed
 fixe

2000 x 1000
 2500 x 1200

fisso
 fixed
 fixe

Ø1400

fisso
 fixed
 fixe

1400 x 1400

su misura
 on measures
 sur mesure

caratteristiche
 characteristic
 caractéristiques

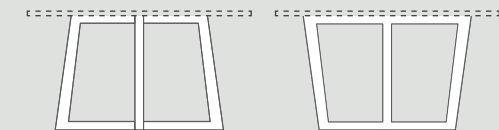

basamento versione 1
 base version 1
 bas version 1

basamento versione 2
 base version 2
 bas version 2



taglio a 45°
 45° cut
 coupe à 45°

slate grey oak
tobacco oak
chalet oak
ash grey oak



Viktor

IT Lo stile essenziale della sedia Viktor è reso caldo e familiare dal legno di rovere o noce.

EN The essential styling of the Viktor chair is made warm and cosy by oak or walnut wood.

FR Le bois de chêne-rouvre ou de noyer confère un aspect chaud et familial au style essentiel de la chaise Viktor.

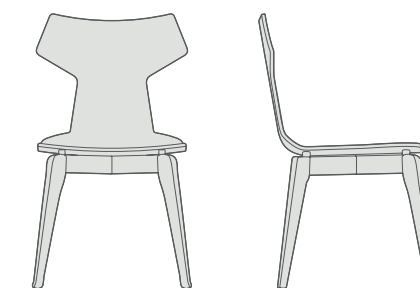

W 495
H 850
D 520

finitura seduta
sitting finish
finition assise



finitura gambe
legs finishes
finition pieds



Hula Hoop

IT La sedia e la poltroncina Hula Hoop, con base a quattro razze di metallo, si abbinano con il tavolo e lo sgabello della stessa famiglia.

EN The Hula Hoop chair and armchair on a four-ray spider base, coordinates with the table and stool in the same family.

FR La chaise et le fauteuil Hula Hoop, avec une base à quatre pieds en métal sont assortis à la table et au tabouret de la même famille.

○

tavolo table
sedia chair
poltrona armchair
sgabello stool

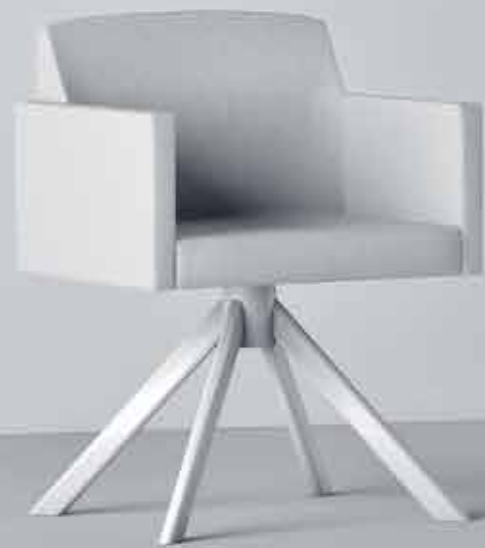

IT La scocca delle sedute è rivestita in tessuto, personalizzabile e completamente sfoderabile.

EN The seat has removable fabric covers that can be customised.

FR La coque des assises est revêtue en tissu, elle est personnalisable et complètement déhoussable.



Hula Hoop s
joint 600
matt black metal
Hula Hoop s
joint 001
matt black metal



○
tavolo table
2000 x 1000
so wood oak
matt white metal

○
sedia chair
joint 315
matt white metal

HULA HOOP S

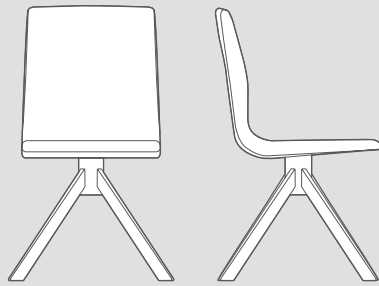

W 530
H 880
D 530

finitura seduta
sitting finish
finition assise



finitura gambe
legs finishes
finition pieds



HULA HOOP P

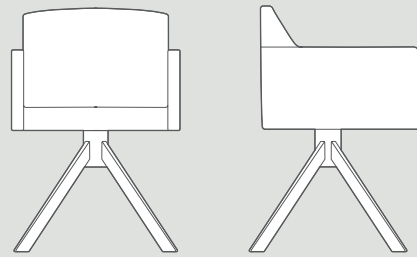

W 570
H 820
D 510

finitura seduta
sitting finish
finition assise



finitura gambe
legs finishes
finition pieds



HULA HOOP SGABELLO



W 550
H 750-1080
D 510

finitura seduta
sitting finish
finition assise



finitura gambe
legs finishes
finition pieds



INDOOR / OUTDOOR
COLLECTION

HULA HOOP TAVOLO



H 770

finitura top
finishes top
finition plan

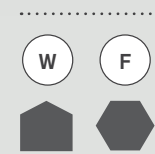

finitura gambe
legs finishes
finition pieds



misure
measures
dimensions

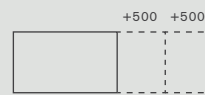

fisso e allungabile
fixed and sliding
fixe et à rallonge

- 1400 x 900
- 1600 x 900
- 1800 x 900
- 2000 x 900
- 1400 x 1000
- 1600 x 1000
- 1800 x 1000
- 2000 x 1000



su misura
on measures
sur mesure

caratteristiche
characteristic
caractéristiques



taglio a 45°
45° cut
coupe à 45°

IT **finiture pag. 46-47** da sinistra: **hula hoop s** tessuto joint 600, metallo bianco; **hula hoop tavolo** fenix NTM® grigio londra, metallo nero; **hula hoop s** tessuto joint 303, metallo nero; **hula hoop sgabello** tessuto joint 315, metallo nero.

EN **finishes pag. 46-47** left: **hula hoop s** joint 600 fabric, white metal; **hula hoop table** in fenix NTM® grigio londra, black metal; **hula hoop s** joint 303 fabric, black metal; **hula hoop stool** joint 315 fabric, black metal.

Brio p
black jack 608
dust oak
Brio s
joint 900
dust oak
Brio p
joint 905
snow oak



Brio

IT Avvolgente come un abbraccio, Brio è disponibile in versione sedia o poltroncina con differenti basamenti.

EN With its cocooning embrace Brio is available as a chair or armchair on different bases.

FR Enveloppant, Brio est disponible en version chaise ou fauteuil avec différentes bases.



○
poltrona armchair



○
sedia chair
reginarca 421
matt white metal

○
poltrona armchair
reginarca 900
matt white metal

BRIO S

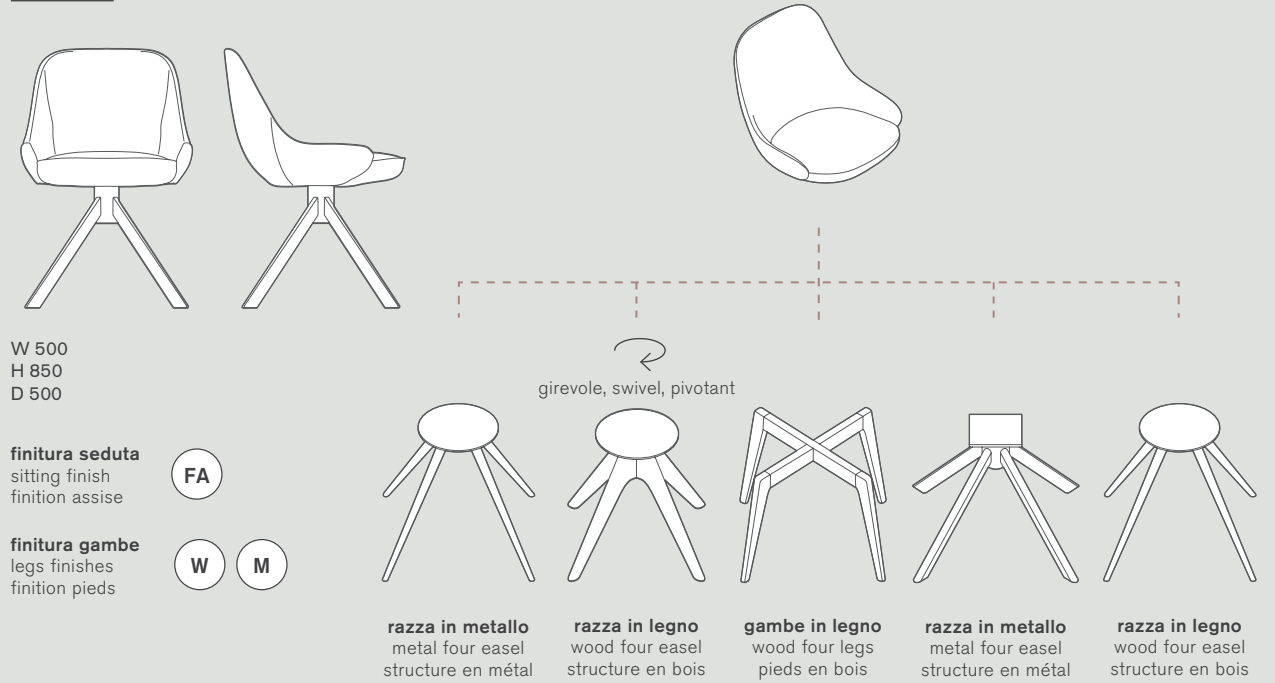

BRIO P

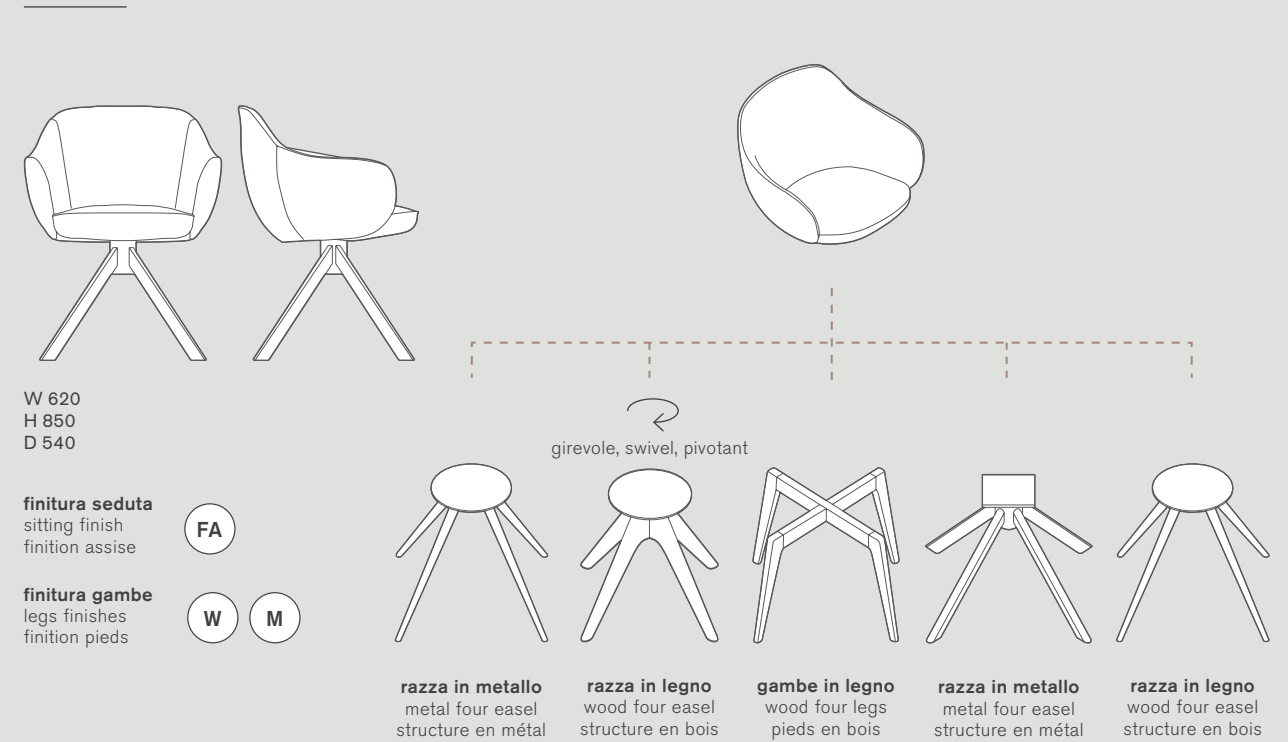



fenix NTM® grigio Londra
natural oak



H 770

finitura top
finishes top
finition plan

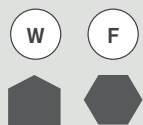

finitura gambe
legs finishes
finition pieds



misure
measures
dimensions

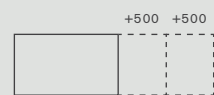

fisso e allungabile
fixed and sliding
fixe et à rallonge

- | | |
|-------------|-------------|
| 1400 x 1400 | 1400 x 1000 |
| 1400 x 900 | 1600 x 1000 |
| 1600 x 900 | 1600 x 1000 |
| 1800 x 900 | 1800 x 1000 |
| 2000 x 900 | 2000 x 1000 |

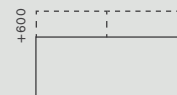

fisso e allungabile
fixed and sliding
fixe et à rallonge

- | |
|-------------|
| 1400 x 1000 |
| 1600 x 1000 |
| 1800 x 1000 |



su misura
on measures
sur mesure

Tai-gà

IT Il fascino nordico incontra i materiali più innovativi in Tai-gà, tavolo con gambe smussate in legno e piano in Fenix NTM®.

EN Nordic charm meets the most innovative materials in Tai-gà, a table with bevelled wooden legs and a Fenix NTM® top.

FR Tai-gà, la table avec des piètements émoussés en bois et un plateau en Fenix NTM® représente la rencontre du charme nordique avec les matériaux le plus innovants.



○

1800 x 1000
fenix NTM® cacao orinoco
tobacco oak

Elle



Elle
joint 900
oxide walnut
Elle
joint 604
black matt metal



IT L'aggraziata semplicità di una curva appena accennata caratterizza Elle, seduta imbottita disponibile con diversi basamenti.

EN The graceful simplicity of a very slight curve distinguishes Elle, with padded seat and a choice of bases.

FR La gracieuse simplicité d'une courbe à peine marquée caractérise Elle, assise rembourrée disponible avec différentes bases.

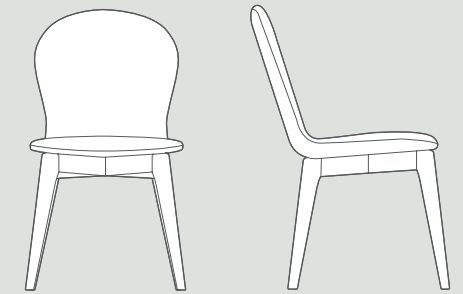

W 510
H 860
D 500

finitura seduta
sitting finish
finition assise



finitura gambe
legs finishes
finition pieds



girevole, swivel, pivotant

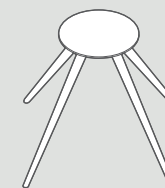

razza in metallo
metal four easel
structure en métal

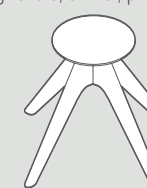

razza in legno
wood four easel
structure en bois

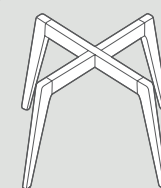

gambe in legno
wood four legs
pieds en bois

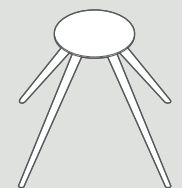

razza in legno
wood four easel
structure en bois

Peggy
 liliium 503
 coal black oak
Peggy
 nord wool 302
 natural oak
Peggy
 joint 900
 natural oak

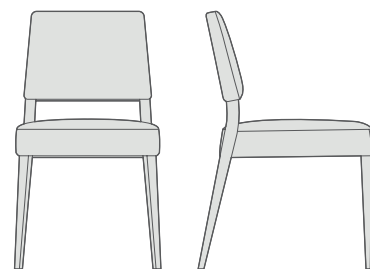

W 480
 H 840
 D 580

finitura seduta
 sitting finish
 finition assise



finitura gambe
 legs finishes
 finition pieds



nord wool 600
 natural oak



Peggy

IT Lo schienale imbottito, ancora più confortevole grazie a una leggera inclinazione, fa di Peggy una sedia comodissima.

EN The inclined padded backrest makes Peggy an extremely comfortable chair.

FR Le dossier rembourré, encore plus confortable grâce à une légère inclinaison, fait de Peggy une chaise de très grand confort.



Essenza

IT Rigoroso, solido, minimale: è il tavolo Essenza, in versione fissa o allungabile.

EN Rigorous, solid, minimal: this is the Essenza table, which has a fixed version and an extending one.

FR Rigoureuse, solide, minimaliste: c'est la table Essenza, en version fixe ou allongeable.



○ **Bolla s** chair reginarca 402 black metal

○ **tavolo** table 2000 x 900 chalet oak

○ **Bolla s** chair reginarca 707 black metal



H 770

finitura top
finishes top
finition plan



finitura gambe
legs finishes
finition pieds



misure
measures
dimensions

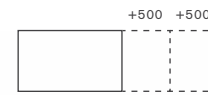

fisso e allungabile
fixed and sliding
fixe et à rallonge

su misura
on measures
sur mesure

- 1400 x 1400
- 1400 x 900
- 1600 x 900
- 1800 x 900
- 2000 x 900
- 1400 x 1000
- 1600 x 1000
- 1800 x 1000
- 2000 x 1000

natural oak



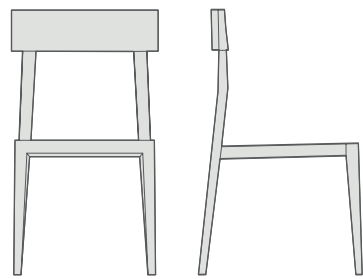

W 470
H 860
D 525

finitura seduta
sitting finish
finition assise



finitura gambe
legs finishes
finition pieds



so wood oak
slate grey oak



INDOOR / OUTDOOR
COLLECTION

IT La classica sedia in legno ripensata con un tocco contemporaneo che la rende perfetta per interni moderni e ricercati.

EN A classical wooden chair revisited with a contemporary touch that makes it perfect for refined modern interiors.

FR La chaise classique en bois repensée avec une touche contemporaine qui la rend parfaite pour les intérieurs modernes et recherchés.

Good



Manila

IT Manila è una sedia in metallo completamente rivestita in tessuto o cuoio rigenerato. Impilabile, si abbina allo sgabello della stessa famiglia.

EN Manila is a metal chair fully upholstered in fabric or bonded leather. It is stackable and coordinates with the stool in the same family.

FR Manila est une chaise en métal complètement revêtue en tissu ou cuir régénéré. Empilable, elle est assortie au tabouret de la même famille.

○

sgabello stool
white smoothed
bonded leather
chromed metal

○

sedia chair
nord wool 702
nord wool 502

○

sedia chair
nord wool 702

MANILA

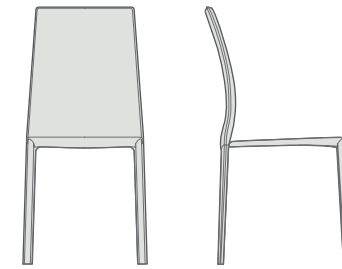

W 475
H 985
D 520

finitura seduta
sitting finish
finition assise



finitura gambe
legs finishes
finition pieds



caratteristiche
characteristic
caractéristiques



sedia impilabile
stackable chair
chaise empilable

MANILA SGABELLO

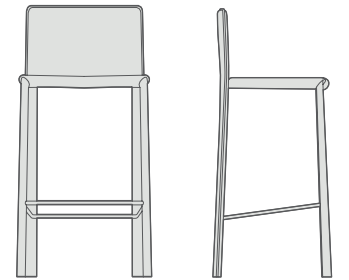

W 435
H 650-860
D 425

W 435
H 780-990
D 425

finitura seduta
sitting finish
finition assise



finitura gambe
legs finishes
finition pieds



white smoothed
bonded leather
chromed metal



Twist

IT Tavolino e poltroncina Twist sono un'abbinata perfetta, sia dentro interni domestici sia per spazi contract.

EN The Twist occasional table and armchair are the perfect pair for the home or contract projects.

FR Table basse et fauteuil Twist sont un ensemble parfait, aussi bien pour les intérieurs domestiques que pour les espaces contract.



○ **tavolino** coffee table
fenix NTM® nero ingo
tobacco oak



○ **poltrona** armchair
flirt 804
tobacco oak

INDOOR / OUTDOOR
COLLECTION

TWIST

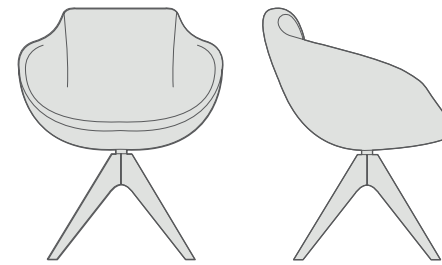

W 680
H 810
D 660

finitura seduta
sitting finish
finition assise



finitura gambe
legs finishes
finition pieds

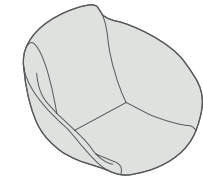

girevole, swivel, pivotant

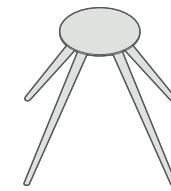

razza in metallo
metal four easel
structure en métal

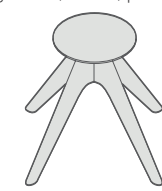

razza in legno
wood four easel
structure en bois

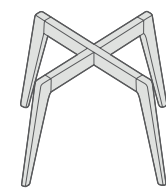

gambe in legno
wood four legs
pieds en bois

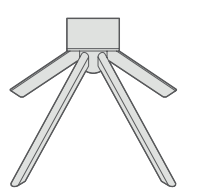

razza in metallo
metal four easel
structure en métal

TWIST TAVOLINO

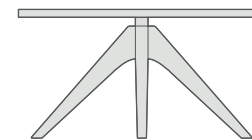

W 600
H 400
D 600

finitura top
finishes top
finition plan



finitura gambe
legs finishes
finition pieds



Nord wool 600
matt black metal



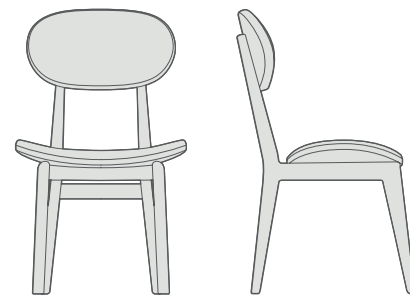

W 550
H 920
D 580

finitura seduta
sitting finish
finition assise



finitura gambe
legs finishes
finition pieds



Nordica
nord wool OV702
snow oak
Nordica
nabucco 400
natural oak
Nordica
reginarca 701
titanium oak

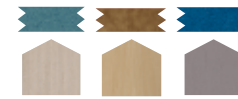

magic 601
natural oak



Nordica

IT L'inclinazione dello schienale e la seduta arcuata di Nordica contribuiscono a rendere attuale questa sedia imbottita d'ispirazione classica.

EN The inclined backrest and arched seat of Nordica help to bring this padded chair of classical inspiration up to date.

FR L'inclinaison du dossier et l'assise courbée de Nordica contribuent à rendre actuel ce siège rembourré d'inspiration classique.

Guggenheim

IT Guggenheim è disponibile nelle versioni sedia, anche completamente rivestita, o sgabello, entrambe con rivestimento personalizzabile.

EN Guggenheim is available as a chair, which can be fully upholstered, or a stool, both with customisable covers.

FR Guggenheim est disponible dans les versions chaise, également complètement revêtue, ou tabouret, tous deux avec des revêtements personnalisables.

GUGGENHEIM SOFT

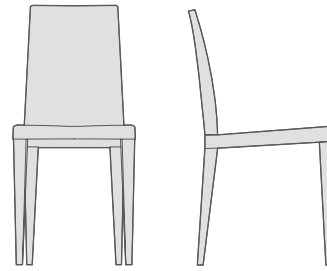

W 425
H 900
D 518

finitura seduta
sitting finish
finition assise



finitura gambe
legs finishes
finition pieds



GUGGENHEIM SGABELLO

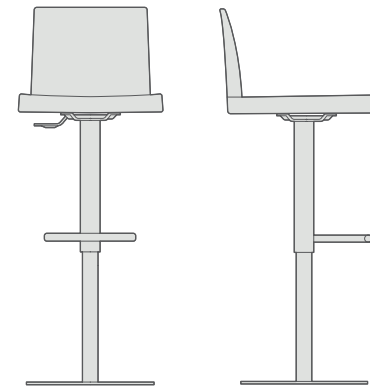

W 390
H 1080
D 390

finitura seduta
sitting finish
finition assise



finitura gambe
legs finishes
finition pieds



caratteristiche
characteristic
caractéristiques

—|— altezza regolabile
adjustable height
hauteur réglable

Guggenheim soft
reginarca 801
tobacco oak
Guggenheim soft
flirt 700
Guggenheim soft
magic 803
titanium oak
Guggenheim stool
magic 700
chromed metal
Guggenheim soft
nord wool 701



Buddy

Buddy
so wood oak
Operà table
fenix NTM®
verde comodoro

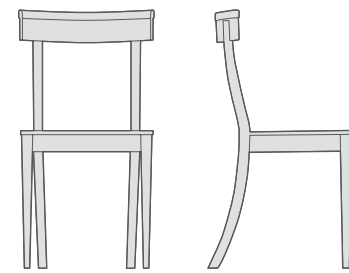

W 440
H 860
D 500

finitura seduta
sitting finish
finition assise



finitura gambe
legs finishes
finition pieds



IT Una sedia dall'aspetto classico, con qualcosa in più: merito della leggera curvatura dello schienale e delle gambe posteriori che la rende unica.

EN A classical-looking chair with that something extra: the unique slightly curved backrest and rear legs.

FR Une chaise à l'aspect classique, avec quelque chose en plus: mérite de la courbure légère du dossier et des piètements postérieurs qui la rendent unique.



dust oak



Tetris

IT Il caratteristico incastro tra gli elementi che sostengono il tavolo, valorizzato dalla finitura in noce nazionale o rovere, è visibile anche sul piano.

EN The characteristic slotted base supporting this table, which features an Italian walnut or oak finish, is also visible on the top.

FR L'encastrement caractéristique entre les éléments qui soutiennent la table, valorisé par la finition en noyer national ou chêne-rouvre, est également visible sur le plateau.



○ **tavolo** table
chalet oak
black matt metal

○ **Brio s** chair
joint 303
chalet oak

○ **Brio p** armchair
joint 814
chalet oak

INDOOR / OUTDOOR
COLLECTION



H 770

finitura top
finishes top
finition plan

W



taglio a 45°
45° cut
coupe à 45°

finitura gambe
legs finishes
finition pieds

W



M



misure
measures
dimensions



fisso
fixed
fixe

su misura
on measures
sur mesure

2000 x 1000
2200 x 1000

chalet oak
black matt metal



flirt 401
natural oak



HERMITAGE S

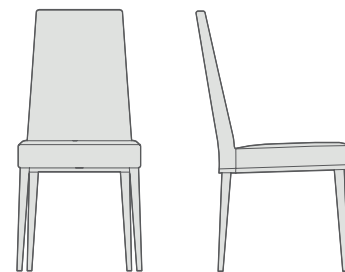

W 475
H 985
D 520

finitura seduta
sitting finish
finition assise



finitura gambe
legs finishes
finition pieds



HERMITAGE P

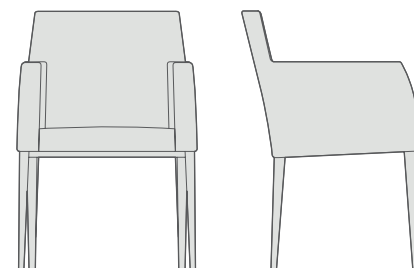

W 590
H 860
D 600

finitura seduta
sitting finish
finition assise



finitura gambe
legs finishes
finition pieds



Hermitage

IT Seduta di sapiente eleganza, Hermitage è disponibile in versione sedia o poltroncina con schienale basso e braccioli.

EN A cleverly elegant chair, Hermitage is available as a chair or easy chair with a low backrest and arms.

FR Hermitage, chaise très élégante, est disponible en version chaise ou fauteuil avec un dossier bas et des accoudoirs.



○
poltrona armchair
lavasi 200
titanium oak

○
tavolo Operà table
fenix NTM® grigio Londra
coal black oak

○
sedia chair
reginarca 402
coal black oak

○
sedia chair
reginarca 700
coal black oak

Perla

IT Perla è un tavolo dal design lineare, disponibile con piano in legno, Fenix NTM® e vetro.

EN Perla is a table of linear design, available with a top in wood, Fenix NTM® or glass.

FR Perla est une table au design linéaire, disponible avec un plateau en bois, Fenix NTM® ou verre.



INDOOR / OUTDOOR
COLLECTION

H 770

finitura top
finishes top
finition plan

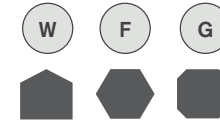

finitura gambe
legs finishes
finition pieds



misure
measures
dimensions

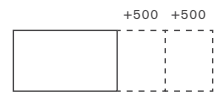

fisso e allungabile
fixed and sliding
fixe et à rallonge

1450 x 900
1650 x 900
1850 x 900



su misura
on measures
sur mesure

Dambè s
nabucco 400
natural oak
Dambè s
reginarca 701
moon grey oak
Perla table
natural oak



+ 500 + 500



white glass
grey smoked oak



TECHNICAL OVERVIEW



Minuetto

IT L'abbinamento di legno e midollino lavorato a mano è la particolarità di Minuetto, sedia impilabile in rovere con seduta imbottita.

EN A combination of wood and hand crafted rattan core is the distinguishing feature of Minuetto, a stackable chair in oak wood, with padded seat.

FR L'assemblage du bois et de la paille travaillée à la main est la particularité de Minuetto, chaise empilable en chêne-rouvre avec une assise rembourrée.



INDOOR / OUTDOOR
COLLECTION

Minuetto
lavasi 702
natural oak

Minuetto
lavasi 702
biscuit oak

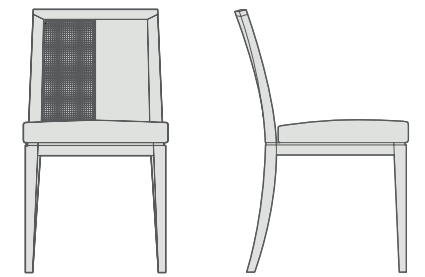

W 455
H 835
D 545

finitura seduta
sitting finish
finition assise



finitura gambe
legs finishes
finition pieds



caratteristiche
characteristic
caractéristiques



sedia impilabile
stackable chair
chaise empilable

titanium oak



nord wool 600

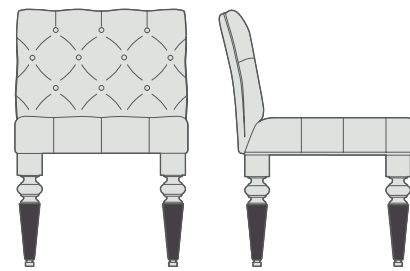

W 550
H 810
D 610

finitura seduta
sitting finish
finition assise

FA

finitura gambe
legs finishes
finition pieds

W



Diva

IT Per la lavorazione capitonné eseguita a mano e le gambe riccamente tornite, questa sedia non passa certo inosservata.

EN With its hand crafted deep buttoning and attractive turned legs, this chair will never go unnoticed.

FR Pour son travail capitonné effectué à la main et ses piètements délicatement tournés, cette chaise ne passe certainement pas inaperçue.



○
joint 702
so wood oak

○

tavolo table
Fenix NTA®
so wood oak

Étoile

IT Ha gambe in legno di forma squadrata e piano in Fenix NTM® o legno il tavolo Étoile, fisso, allungabile o su misura.

EN The Étoile table has square legs and a top in Fenix NTM® or wood, and comes fixed, extending or made to measure.

FR La table Étoile, fixe et allongeable ou sur mesure, a des piètements en bois de forme carrée et un plateau en Fenix NTM® ou en bois.



○

Bolla s chair
magic 700
white metal

H 770

finitura top
finishes top
finition plan

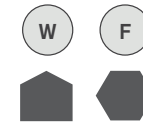

finitura gambe
legs finishes
finition pieds



misure
measures
dimensions

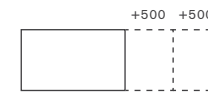

fisso e allungabile
fixed and sliding
fixe et à rallonge

1400 x 1400
1400 x 900
1600 x 900
1800 x 900
2000 x 900
1400 x 1000
1600 x 1000
1800 x 1000
2000 x 1000

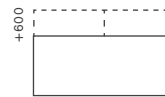

fisso e allungabile
fixed and sliding
fixe et à rallonge

1400 x 1000
1600 x 1000
1800 x 1000



su misura
on measures
sur mesure

+ 500 + 500



Fenix NTM® grigio bromo
biscuit oak



Cannella

IT Per il rivestimento in tessuto e per il ricciolo dello schienale e delle gambe, Cannella è la perfetta via di mezzo tra sedia e poltroncina.

EN With its fabric upholstery and the backrest and leg scroll, Cannella is the perfect a cross between a chair and an easy chair.

FR Pour le revêtement en tissu et pour le recyclage du dossier et des piètements, Cannella est le compromis parfait entre la chaise et le fauteuil.

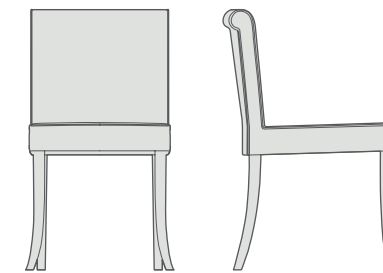

W 495
H 870
D 600

finitura seduta
sitting finish
finition assise

FA

finitura gambe
legs finishes
finition pieds

W

○
magic 430
terra oak

○
magic 406
terra oak



○
magic 700
terra oak

○
joint 503
terra oak



IT La classica sedia in rovere con seduta imbottita è resa speciale dalla lavorazione a spaccafilo che contraddistingue lo schienale, eseguita a mano.

EN A classical oak chair with padded seat is made special by the hand crafted groove framing the backrest.

FR La chaise classique en chêne-rouvre avec assise rembourrée est rendue spéciale par le travail à rainure, fait à la main, qui caractérise le dossier.

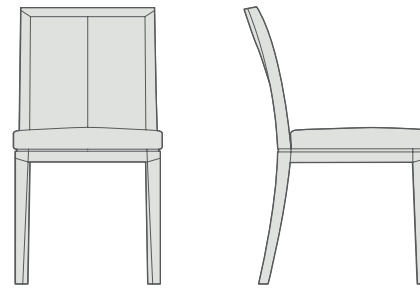

W 455
H 835
D 545

finitura seduta
sitting finish
finition assise



finitura gambe
legs finishes
finition pieds



caratteristiche
characteristic
caractéristiques



sedia impilabile
stackable chair
chaise empilable

National
nord wool 600
natural oak
National
nord wool 801
snow oak
National
nord wool 200
coal black oak

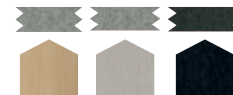

National



○
reginarca 501
grey smoked oak

○
reginarca 402
titanium oak

La-mu

IT Ispirazione orientale per la sedia La-mu, con gambe a slitta in legno e seduta imbottita.

EN Oriental inspiration for the La-mu chair with wooden sled-style base and padded seat.

FR Inspiration orientale pour la chaise La-mu, avec piètements luge en bois et assise rembourrée.



Ufo coffe table
fenix NTM® blu fes
coal black oak
La-mu
flirt 804
coal black oak

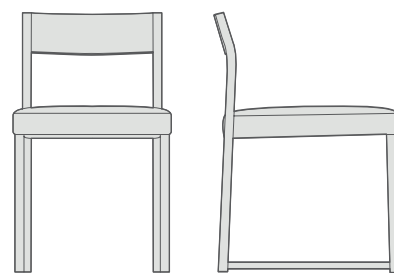

W 460
H 760
D 540

finitura seduta
sitting finish
finition assise



finitura gambe
legs finishes
finition pieds



INDOOR / OUTDOOR
COLLECTION

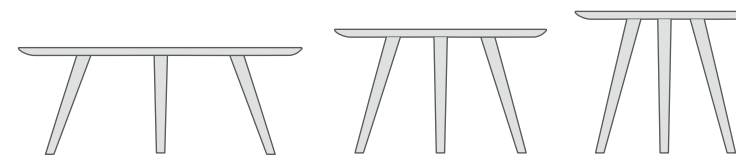

Ø 800

Ø 600

Ø 500

altezze disponibili
available heights
hauteurs disponibles

H 300
H 350
H 400

finitura top
finishes top
finition plan



finitura gambe
legs finishes
finition pieds



chalet oak



fenix NTM®
grigio bromo
terra oak



terra oak

IT Tre misure, tre diametri e diverse finiture tra cui scegliere per il tavolino, un *passé-partout* per interni domestici così come per gli spazi contract.

EN Three sizes, three diameters and a wide choice of finishes for this occasional table, a *passé-partout* for the home and contract projects.

FR Trois dimensions, trois diamètres et différentes finitions au choix pour la table basse, un *passé-partout* pour les intérieurs domestiques ainsi que pour les espaces contract.



Ufo

titanium oak



Queen

IT Nella sedia Queen la certezza di una forma tradizionale sposa la solidità del legno di rovere.

EN The Queen chair exudes the certainty of traditional styling combined with robust oak wood.

FR Dans la chaise Queen, l'assurance d'une forme traditionnelle épouse la solidité du bois de chêne-rouvre.

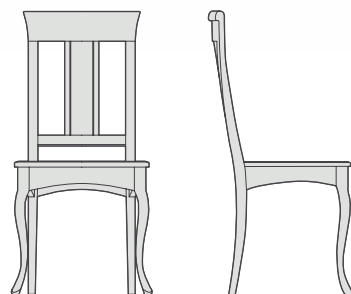

W 495
H 1000
D 480

finitura seduta
sitting finish
finition assise

W

finitura gambe
legs finishes
finition pieds

W

INDOOR / OUTDOOR
COLLECTION



so wood oak



IT Ha una fisionomia antica Barboun, tavolo da pranzo con gambe sinuose che richiama uno stile d'altri tempi.

EN Barboun has an old-world look: a dining table with willowy legs reminiscent of the style of years gone by.

FR Barboun, table pour les repas avec des piètements sinueux et qui rappelle un style d'une autre époque, possède une physionomie ancienne.

+ 500 + 500



H 770

finitura top
finishes top
finition plan



wenge oak



finitura gambe
legs finishes
finition pieds



misure
measures
dimensions

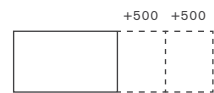

fisso e allungabile
fixed and sliding
fixe et à rallonge

1400 x 1400
1400 x 900
1600 x 900
1800 x 900

su misura
on measures
sur mesure

INDOOR / OUTDOOR
COLLECTION



slate grey oak
dust oak



Barboun

IT Ha un profilo snello e slanciato questo sgabello con piccolo sedile e struttura in metallo, regolabile all'altezza desiderata.

EN This stool has a slim, streamlined profile with its small seat and height adjustable metal frame.

FR Ce tabouret avec une petite assise et une structure en métal, réglable à la hauteur désirée, a un profil fin et élancé.

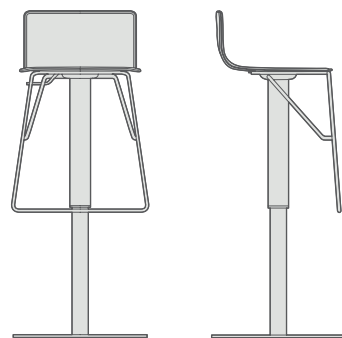

W 405
H 950
D 390

finitura seduta
sitting finish
finition assise



caratteristiche
characteristic
caractéristiques



altezza regolabile
adjustable height
hauteur réglable

finitura gambe
legs finishes
finition pieds



INDOOR / OUTDOOR
COLLECTION

Lussuria



Lussuria
grey smooth
bonded leather
chromed metal
Lussuria
bordeaux smooth
bonded leather
chromed metal



Lussuria
red smooth
bonded leather
chromed metal
Lussuria
dove grey smooth
bonded leather
chromed metal



Baba
 magic 913
 black matt metal

Baba
 nord wool 403
 black matt metal

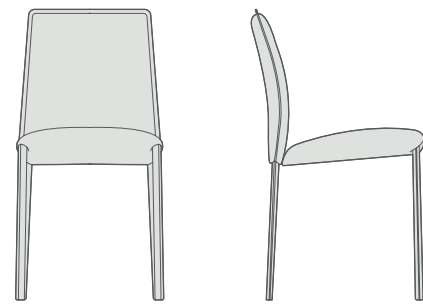

W 440
 H 870
 D 470

finitura seduta
 sitting finish
 finition assise



finitura gambe
 legs finishes
 finition pieds



Baba

IT L'imbottitura e lo schienale lievemente arcuato rendono confortevole la sedia rivestita Baba.

EN The padding and slightly curved backrest make the Baba upholstered chair very comfortable.

FR Le rembourrage et le dossier légèrement courbé rendent la chaise revêtue Baba confortable.



○
 nord wool 403

○
 joint 900
 black metal

○
 nord wool 403

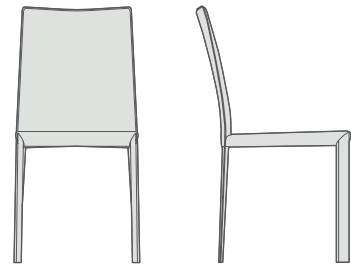

W 445
H 895
D 540

finitura seduta
sitting finish
finition assise



finitura gambe
legs finishes
finition pieds



Bistrot
bordeaux rough bonded leather
Bistrot
dove grey rough bonded leather
Bistrot
white rough bonded leather
Bistrot
grey rough bonded leather



Bistrot

IT Bistrot unisce le caratteristiche di resistenza di una seduta in metallo con l'estetica del rivestimento in cuoio rigenerato colorato.

EN Bistrot brings together the resistance of a metal chair and the good looks of its coloured bonded leather upholstery.

FR Bistrot unit les caractéristiques de résistance d'une assise en métal avec l'esthétique du revêtement en cuir régénéré coloré.



inca 22
slate grey oak

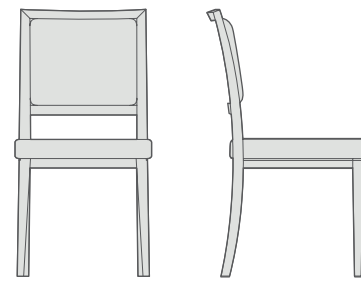

W 465
H 900
D 540

finitura seduta
sitting finish
finition assise



finitura gambe
legs finishes
finition pieds



Met
inca 600
chalet oak
Met
inca 22
chalet oak
Met
inca 17
chalet oak



Met

IT La sedia Met si distingue per lo schienale incorniciato, imbottito così come la seduta.

EN The Met chair is distinguished by its framed backrest which is also padded like the seat.

FR La chaise Met se distingue par son dossier encadré, rembourré tout comme l'assise.



+ 500 + 500



H 770

finitura top
finishes top
finition plan

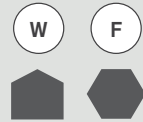

finitura gambe
legs finishes
finition pieds



misure
measures
dimensions

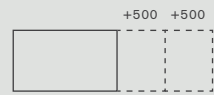

fisso e allungabile
fixed and sliding
fixe et à rallonge

1400 x 1400
1400 x 900
1600 x 900
1800 x 900

su misura
on measures
sur mesure

Bridge

IT La struttura in rovere massello fa di Bridge un tavolo solido e robusto. Il piano si può personalizzare con finiture e materiali diversi.

EN Its solid oak structure makes Bridge a substantial, robust table. The top can be customised with different finishes and materials.

FR La structure en chêne-rouvre massif fait de Bridge une table solide et robuste. Le plateau est personnalisable avec des finitions et des matériaux différents.



Up sgabello stool
black plastic
natural oak



O tavolo table
1800 x 900
natural oak
coal black oak

O Bolla p armchair
joint 601
so wood oak

Bridge
so wood oak
Bolla p
joint 601
so wood oak

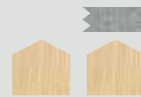

RETRÒ S

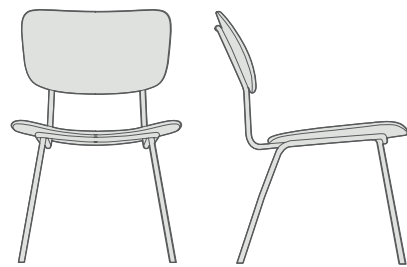

W 480
H 775
D 555

finitura seduta
sitting finish
finition assise



finitura gambe
legs finishes
finition pieds



RETRÒ P

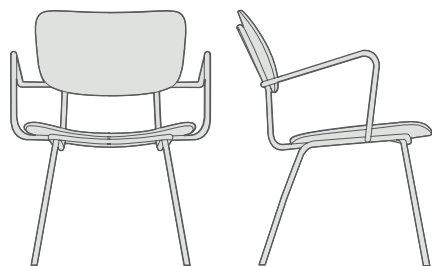

W 570
H 775
D 555

finitura seduta
sitting finish
finition assise



finitura gambe
legs finishes
finition pieds



INDOOR / OUTDOOR
COLLECTION

Retrò

IT Suggestioni vintage con Retrò, sedia e poltroncina con struttura in metallo verniciato opaco e seduta e schienale in legno di noce nazionale o rovere.

EN A vintage air for Retrò, a chair and armchair with matt painted metal frame and Italian walnut or oak wood backrest.

FR Suggestions vintage avec Retrò, chaise et fauteuil avec structure en métal verni mat et assise en bois de noyer national ou chêne-rouvre.



○
Retrò s chair
natural oak
black matt metal

○
Retrò s chair
titanium oak
white matt metal

○
Retrò p armchair
oxide walnut
black matt metal

○
Retrò p armchair
oxide walnut
white matt metal

Salsa e Merengue

○

Merengue
white smooth
bonded leather
chromed metal



○

Salsa
red smooth
bonded leather
chromed metal



○

Merengue
black smooth
bonded leather
chromed metal



INDOOR / OUTDOOR
COLLECTION

SALSA

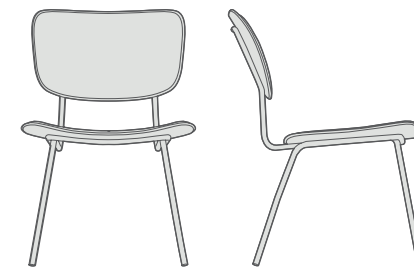

W 495
H 775
D 555

finitura seduta
sitting finish
finition assise



finitura gambe
legs finishes
finition pieds



MERENGUE

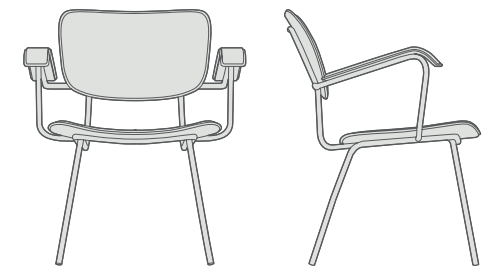

W 630
H 775
D 555

finitura seduta
sitting finish
finition assise



finitura gambe
legs finishes
finition pieds



IT Con l'aggiunta dei braccioli rivestiti, la sedia Salsa diventa una comoda poltroncina Merengue.

EN With the addition of upholstered arms, the Salsa chair becomes the comfortable Merengue armchair.

FR Avec l'ajout des accoudoirs revêtus, la chaise Salsa devient le fauteuil confortable Merengue.

white smooth
bonded leather
chromed metal



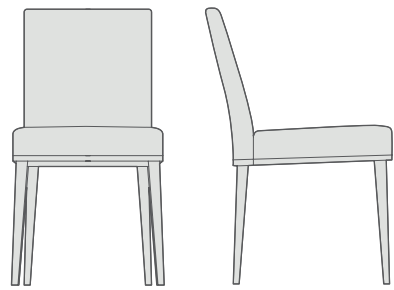

W 475
H 860
D 520

finitura seduta
sitting finish
finition assise



finitura gambe
legs finishes
finition pieds



IT Classe senza tempo per Coco, sedia in legno vestita di tessuto sfoderabile.

EN Timeless class for Coco, a wooden chair with a removable fabric cover.

FR Classe intemporelle pour Coco, chaise en bois revêtue de tissu déhoussable.

lavasi 601
oxide walnut



Coco



Coco
joint 714
oxide walnut
Coco
joint 303
moon grey oak

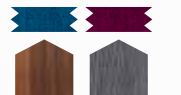



Tra semplicità e ricercatezza, la collezione Oplà di Imperial Line è fresca e colorata, come un giorno d'estate. Un omaggio alla bella stagione e agli spazi all'aperto.

EN SIMPLE AND REFINED, THE OPLÀ IMPERIAL LINE COLLECTION IS AS FRESH AND COLOURFUL AS A SUMMER DAY. IDEAL FOR THE HOT SEASON AND OUTDOOR AREAS.

FR ENTRE SIMPLICITÉ ET SOPHISTICATION, LA COLLECTION OPLÀ DE IMPERIAL LINE EST FRAICHE ET COLORÉE, COMME UN JOUR D'ÉTÉ. UN HOMMAGE À LA BELLE SAISON ET AUX ESPACES EXTÉRIEURS.

Oplà

○

Oplà sgabello stool
signal black



IT Struttura leggera in tubolare metallico e colori vivaci per la perfetta seduta da esterno, nelle versioni sedia, poltroncina e sgabello.

EN A light-weight tubular metal structure and bright colours for the perfect outdoor chair, also available as an armchair and stool.

FR Structure légère en tube métallique et couleurs vives pour une assise parfaite pour l'extérieur, dans les versions chaise, fauteuil et tabouret.

○

Oplà p armchair
reseda green
outdoor pillow 609



○

Oplà s chair
signal white





○
Oplà sgabello stool
golden yellow

○
Oplà p armchair
ruby red



○
Oplà p armchair
orange brown



○
Oplà s chair
signal black

OPLÀ S

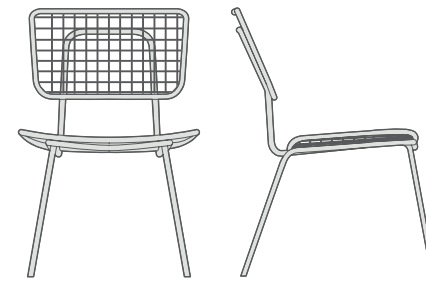

W 490
H 775
D 560

finitura seduta
sitting finish
finition assise



caratteristiche
characteristic
caractéristiques



sedia impilabile
stackable chair
chaise empilable

finitura gambe
legs finishes
finition pieds



OPLÀ P

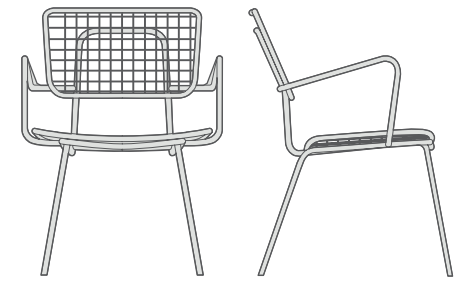

W 560
H 775
D 560

finitura seduta
sitting finish
finition assise



finitura gambe
legs finishes
finition pieds



OPLÀ SGABELLO

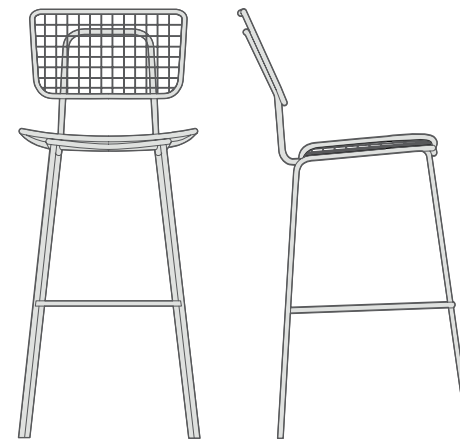

W 525
H 1100
D 610

finitura seduta
sitting finish
finition assise



finitura gambe
legs finishes
finition pieds



signal black

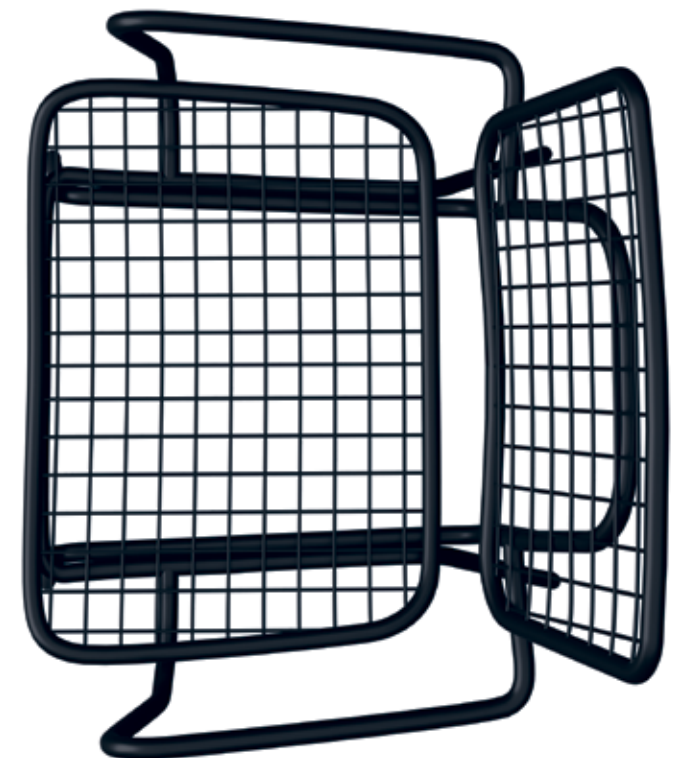

FINITURE E MATERIALI

FINISHES AND MATERIALS
FINITIONS ET MATERIAUX

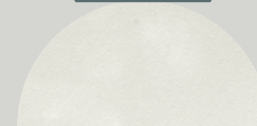
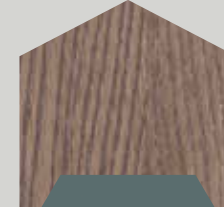



NORD WOOL

lana rigenerata / regenerated wool
laine régénérée

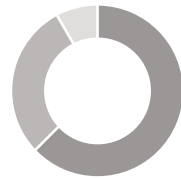

70% WO
25% NY
5% AF

701	001	OV 300	403
OV 704	OV 003	303	405
OV 703	OV 007	300	201
OV 702	502	306	200
702	801	406	600
002	802	401	OV 200
003	OV 802	404	OV 100
OV 006	302	402	



FLASH NATIVA



100% PP

403	200	003	501
409	602	002	500
405	601	001	800
408	600	900	810
402	707	300	804
400	700	310	
101	705	305	
111	710	301	



LAVASÌ



100% PL



003



002



702



501



301



804



305



304



303



100



400



401



402



405



601



600



111



200



LILIUM

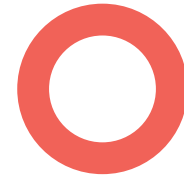

100% PL



005



002



001



709



700



701



705



505



504



503



301



300



303



304



305



100



805



806



804



405



427



900



401



414



411



101



605



606



201



SWEET LIFE

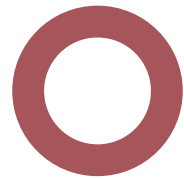

100% PL



FLIRT



100% PL

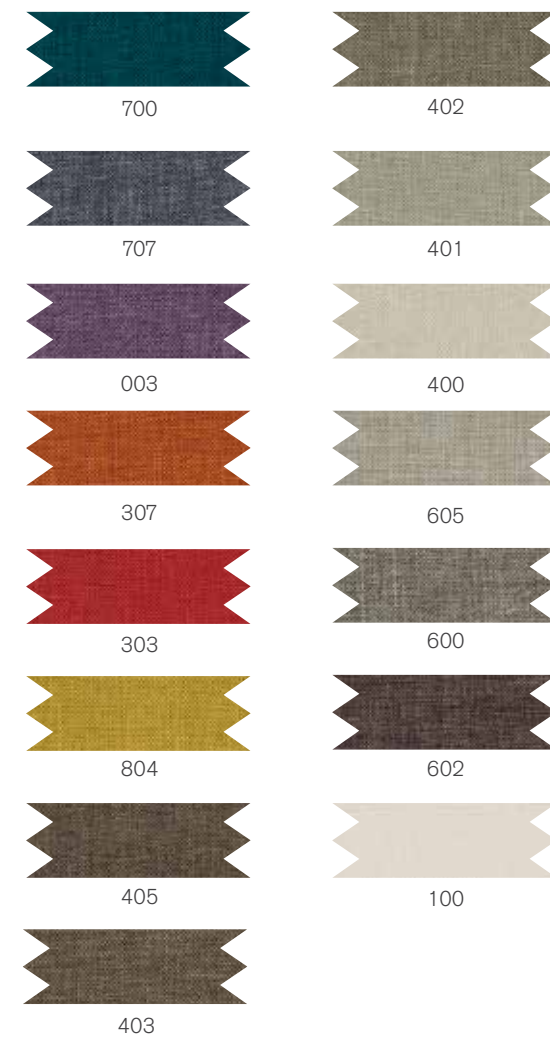

MASTER

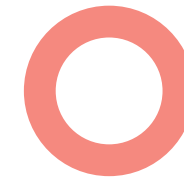

100% PL



FA

REGINARCA

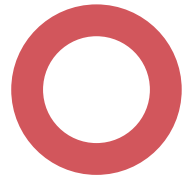

100% PL



103



101



100



423



411



401



606



602



400



414



412



406



404



413



415



416



421



405



402



403



500



501



502



307



301



308



315



314



304



318



310



303



305



302



309



300



900



806



603



601



600



801



805



807



804



802



800



803



605



001



706



707



705



702



700



711



701



002



005



911



912



511



811



708



200

FA

INCA

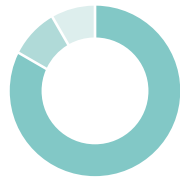

88% PVC
6% PL
6% CO



FA

NABUCCO

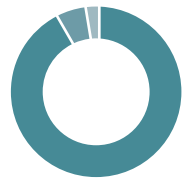

90% PVC
7% PL
3% CO



Per la versione vera pelle contattare gli uffici commerciali; for the real leather version ask to our sales department; pour la version vrai cuir contacter les Bureau commercial.

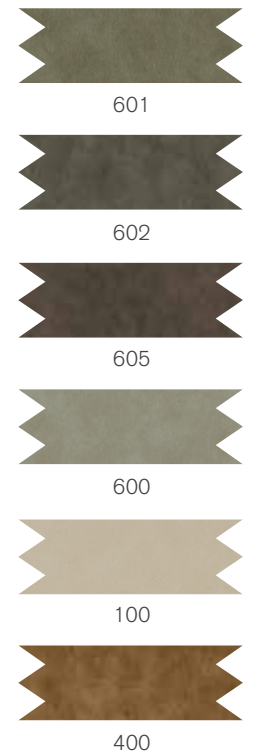



JOINT

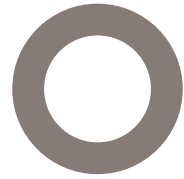

100% PL

111	406	305	900
401	412	314	905
400	812	315	002
403	800	303	806
402	814	001	702
603	503	901	805
612	307	910	706
405	301	903	714



BLACK JACK

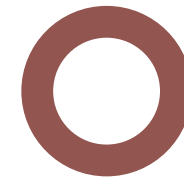

100% PL

704	111	700	200
600	411	702	
611	603	705	
601	405	912	
604	310	008	
200	307	009	
	305	605	
	804	608	

FA

MAGIC



100% PP



L

CUOIO RIGENERATO
bonded leather / cuir régénéré



IT 65% fibre di cuoio naturali
18% lattice naturale
10% acqua
5% grassi e prodotti naturali per conciare le fibre

EN 65% natural leather fibres
18% natural latex
10% water
5% grease or other natural products use to tan fibres

FR 65 % fibres de cuir naturelles
18% latex naturel
10% eau
5% graisses et produits naturels pour tanner les fibres

LISCIO
smooth / lisse

GOFFRATO
rough / gaufré



F

FENIX NTM®



bianco malè

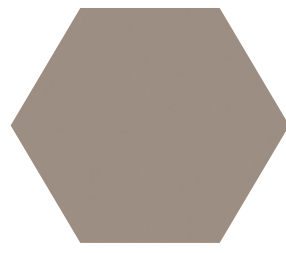

castoro ottawa

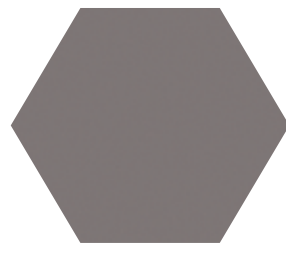

grigio Londra

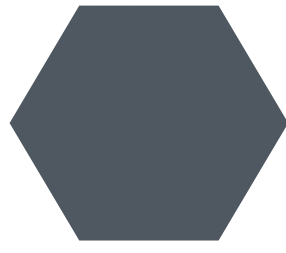

grigio bromo



nero ingo

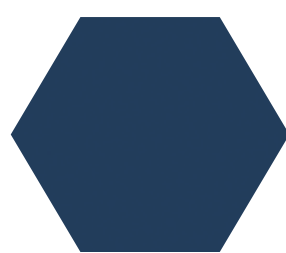

blu fes

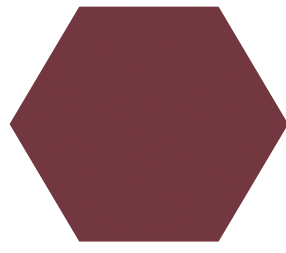

rosso jaipur

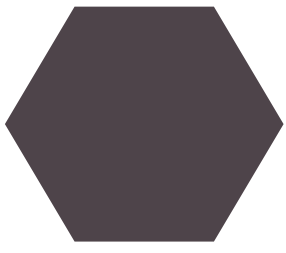

cacao orinoco

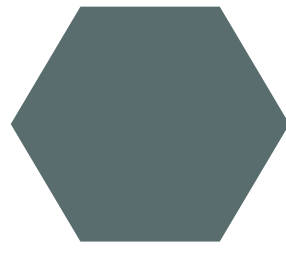

verde comodoro

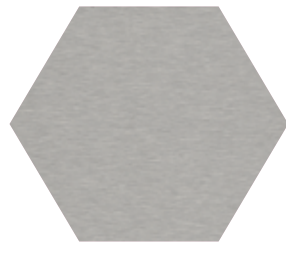

fenix NTA®

M

METALLO

metal / métal

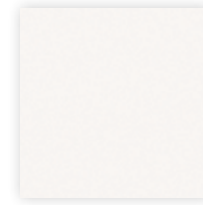

verniciato bianco opaco
matt white painted
verni blanc mat



verniciato nero opaco
matt black painted
verni noir mat

G

VETRI

glasses / verres



bianco
white / blanc

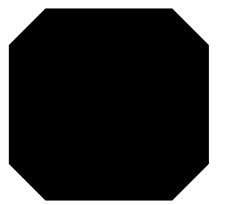

carbone
coal black / charbon

CO

CEMENTO

concrete / béton



CT

HPL COR-TEN

cor-ten / cor-ten



W

LEGNI
wood / bois

ROVERE
oak / chêne



bianco
white / blanc



caffè
coffee / café



cenere
ash grey / cendre



fumo
smoked grey / fumée



naturale
natural / naturel



carbone
coal black / charbon



neve
snow / neige



polvere
dust / poussière



tabacco
tobacco / tabac

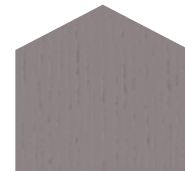

titanio
titanium / titane



wengé
wenge / wengé



biscotto
biscuit / biscuit



ardesia
slate grey / ardoise



so wood
so wood / so wood

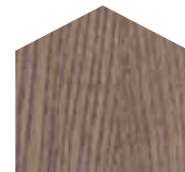

terra
terra / terra



chalet
chalet / chalet

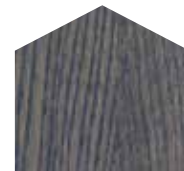

grigio luna
moon grey / gris lune

NOCE
walnut / noyer



noce ossido
oxide walnut / noyer oxyde

MO

METALLO VERNICIATO OPACO

matt painted metal
métal verni mat



bianco segnale
signal white / blanc signal



nero segnale
signal black / noir signal



giallo oro
golden yellow / jaune or



rosso rubino
ruby red / rouge rubis



verde reseda
reseda green / vert reseda



blu azzurro
light blue / bleu clair



marrone arancio
orange brown / marron orange

FO

TESSUTI OUTDOOR
tessuti outdoor / tissus outdoor



100% PC



609



209



419



706



303



800

THANKS TO

CONCEPT E ART DIRECTION
imagodesign - Antonella di Nuzzo

GRAPHIC DESIGN
imagodesign - Antonella di Nuzzo

COPYWRITING
Lisa Cadamuro

DIGITAL IMAGES
imagodesign

FOTOLITO
Luce group

STAMPA
Agcm - Aprile 2018

IMPERIAL LINE SRL
via A. Volta, 3
30029 La Salute di Livenza (VE)
tel. +39 0421.290378
fax. +39 0421.291219
info@imperial-line.com
www.imperial-line.com

SEGUITECI / FOLLOW US ON:



